



TEMPTATION

Recycling bin, covered FF3D

Volume	50 / 70 / 50 Liter
Compartments	3
Casing material	1.4301 (AISI 304) stainless steel, brushed
Casing material thickness	1,5 mm 2,0 mm (cover)
Inner liner material	galvanized steel leakproof
Width	972 mm
Depth	392 mm
Height	1037 mm
Weight	approx. 69,0 kg
Slot size	140 x 140 mm
Accessible height	857 mm
Accessoires / Options	see FEATURES

AUWEKO GmbH · Dornhofstraße 34 · 63263 Neu-Isenburg
Telefon: +49 6103 804955-0 · Fax: +49 6103 804955-10 · Email: vertrieb@auweko.de · Website: www.auweko.de

Copyright declaration:

All sketches, drawings and electronic information are the property of AUWEKO GmbH in Neu-Isenburg. The use of these documents, hard copies or information is permitted for internal purposes only. Forwarding to third parties is not authorised. Subject to technical alteration. © AUWEKO GmbH, 63263 Neu-Isenburg

TEMPTATION

Recycling bin, covered

FF3D

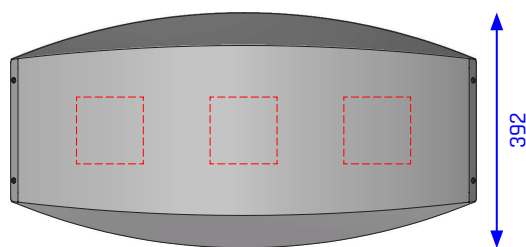
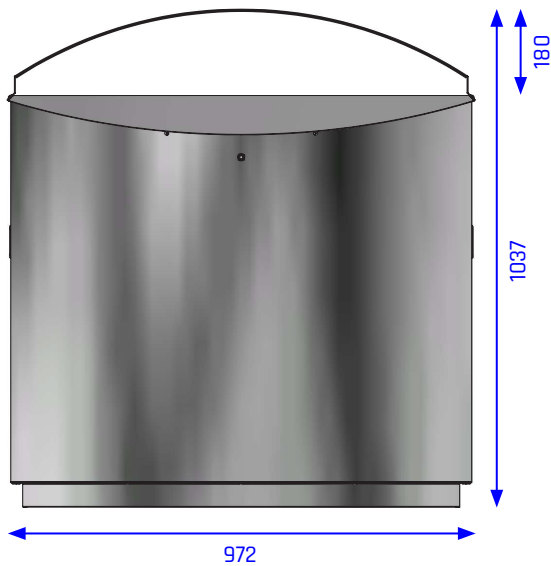

Description: Self-supporting, curved fronts and flat side panels made of stainless steel, secured with an internal construction of galvanized steel, provide great stability. The tops funnel-shaped openings guide waste into the inner liners and are also an elementary part of the fire protection (patented and certified).

Safety: The galvanized inner liners are sealed by a patented system. In the event of a fire, the rising smoke gases collect below the funnel-shaped openings. The resulting gas cushion interrupts the oxygen supply and a self-extinguishing effect occurs. In addition, the construction (inner liners / outer body) minimizes the increase in temperature at, above and below the casing in the event of fire. A snap lock protects the receptacle against unauthorized access.

Additional coverage of the openings for unprotected/ outdoor areas.

Handling: Quick and easy removal of the waste bags from above. The top part of the bin automatically swivels upwards by means of a gas spring after operating the lock (1/4 turn). The contents are now visible and the waste bags can be replaced as required.